

WOODEN CAT CRATE

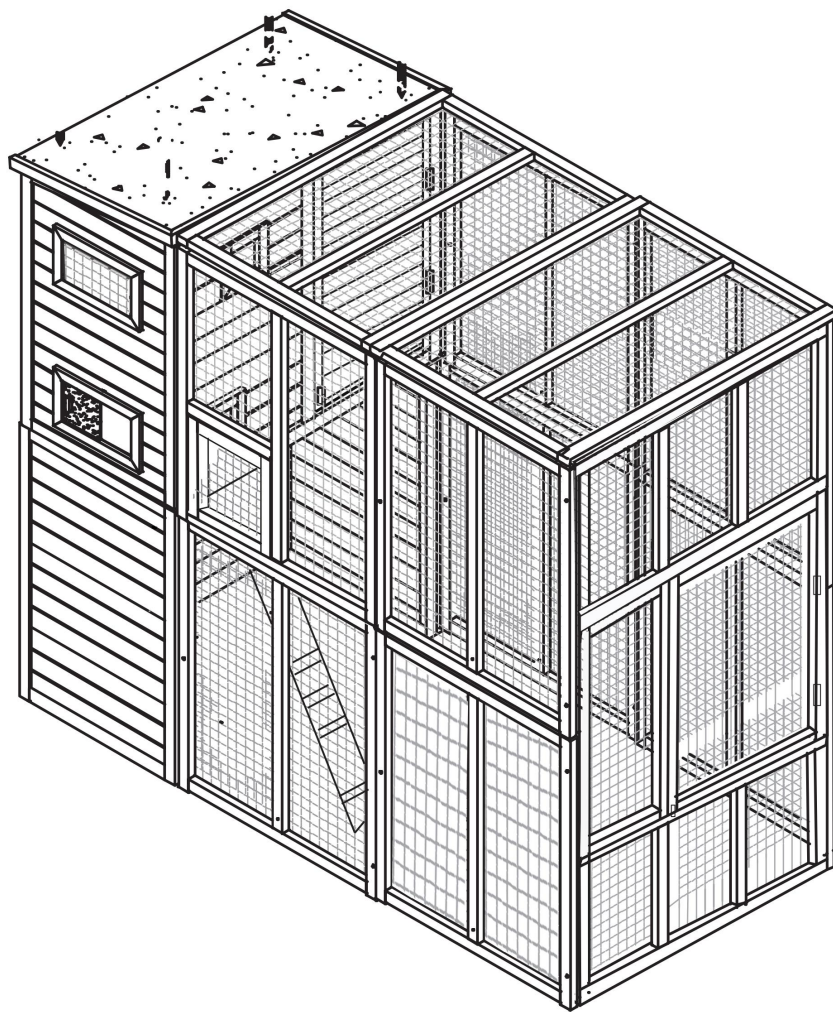

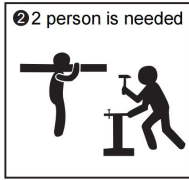

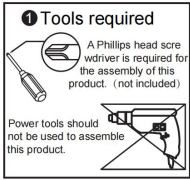





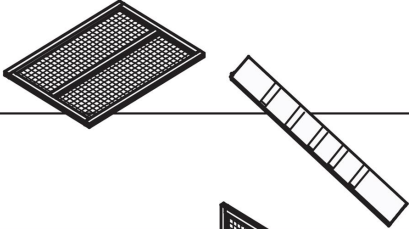
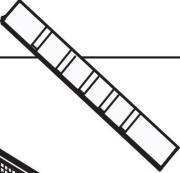

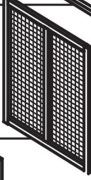

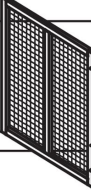
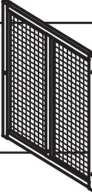
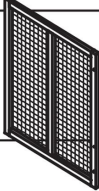
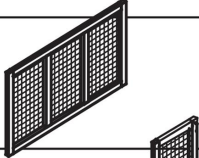

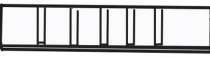

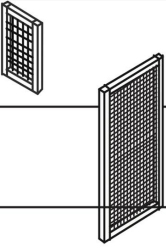
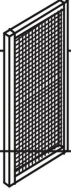



You need



Technical Specifications	
Material	wood
Colour	Gray

Pos.	Description		Quantity	Box Number
1	Upper front part		1	-12
2	Lower front part		1	-12
3	Upper back wall		1	-12
4	Lower back wall		1	-12
5	Upper side panel, left		1	-12
6	Lower side panel		2	-22
7	Upper side panel, right		1	-12
8	Roof		1	-12
9	Upper door		1	-22
10	Middle/lower door		2	-22
11	Step		1	-22

Pos.	Description		Quantity	Box Number
12	Cage roof Six holes/seven holes		2	-22
13	Inner ramp		1	-22
14	Upper cage side panel, rear left		1	-22
15	Lower cage side panel Eight holes		2	-22
16	Upper cage side panel, rear right Six holes		1	-22
17	Upper cage side panel Zero holes		2	-22
18	Lower cage side panel, front left Two holes		1	-22
19	Lower cage side panel, front right Three holes		1	-22
20	Upper/lower cage front part		2	-12
21	Lower cage front part		1	-12
22	Outer ramp		1	-22
23	Outer ramp		1	-22
24	Upper front part door		1	-12
25	Upper cage side panel, rear left		1	-22
26	Lower cage front part door		1	-12
27	Upper/middle side, left/right		2	-22
28	Upper/middle side, middle		1	-22

Pos.	Description		Size	Quantity	Box Number
A	Countersunk screw		m4 x 50 mm	40+1 (gift)	-12
B	Countersunk screw		m4 x 40 mm	12+1 (gift)	-12
C	Countersunk screw		m4 x 35 mm	41+1 (gift)	-12
D	Countersunk screw		m3 x 20 mm	24+1 (gift)	-12
E	Countersunk screw		m3 x 12 mm	42+1 (gift)	-12
F	Countersunk screw		m3 x 10 mm	12+1 (gift)	-12
G	Hinge			9	-12
H	Bolt			3	-12
I	Countersunk screw		m3 x 16 mm	4+1 (gift)	-12
J	Guide book			1	-12

 Check the package contents before getting started !

STEP 1

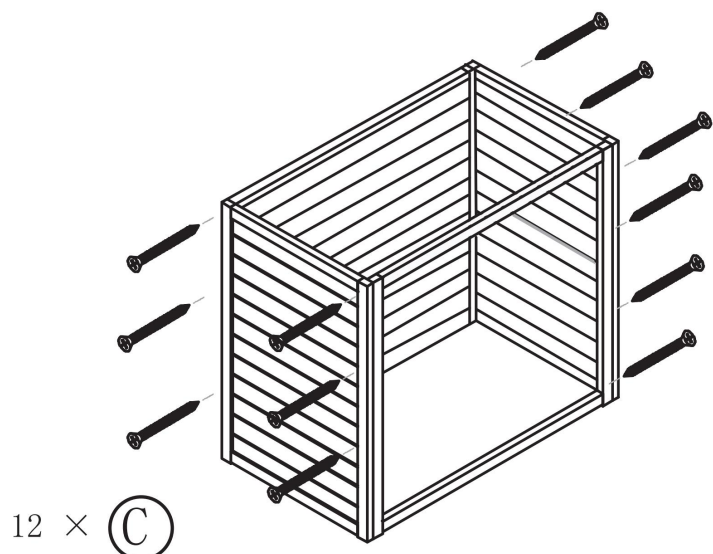
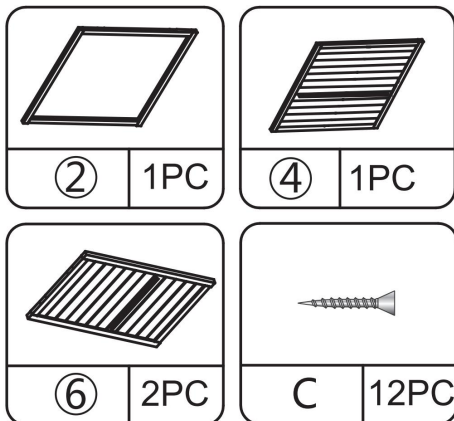

STEP 2

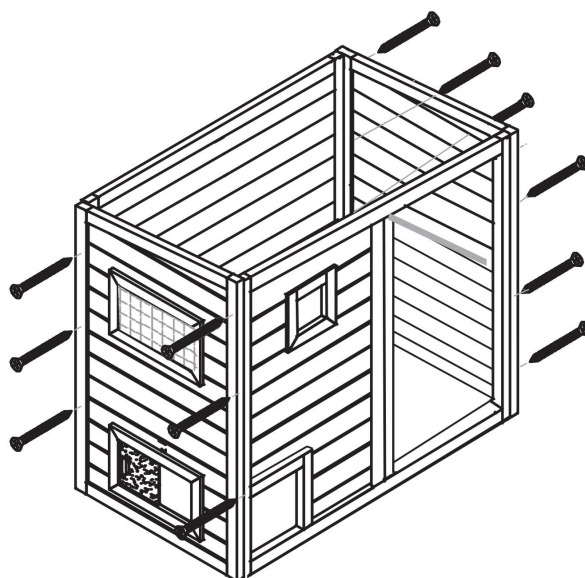
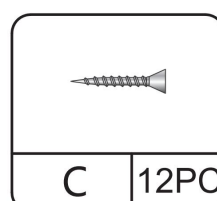
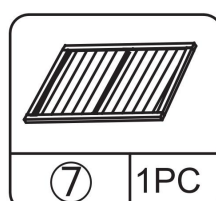
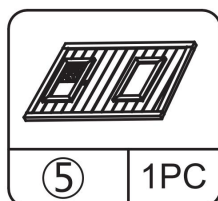
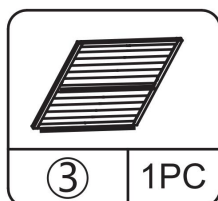
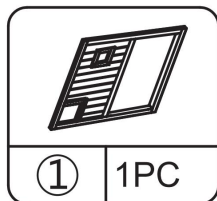

12 × (C)

STEP 3

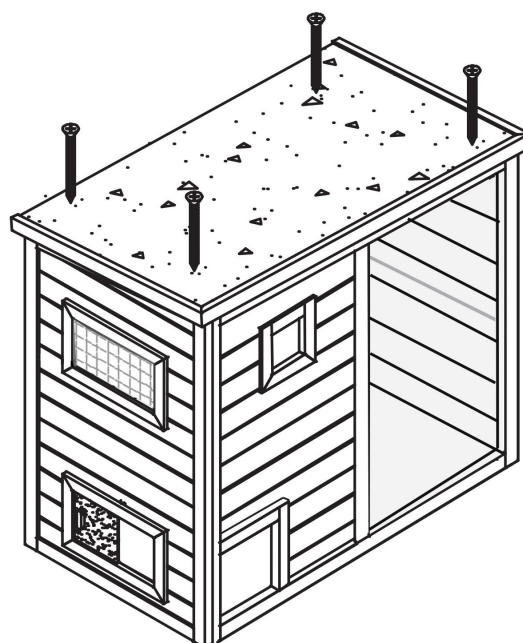
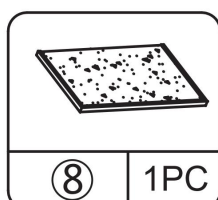
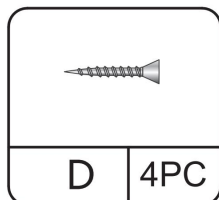

4 × (D)

STEP 4

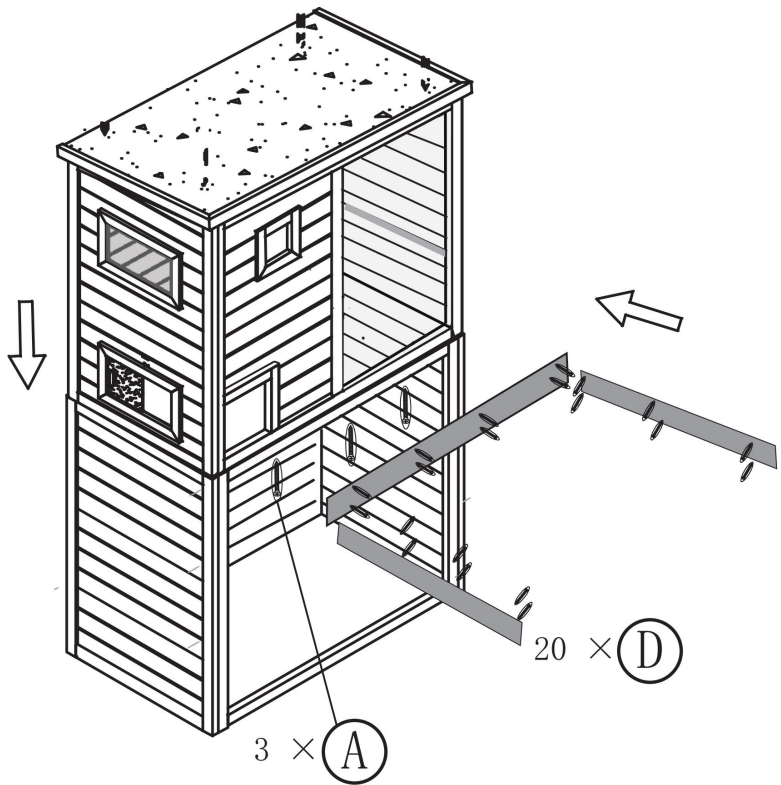
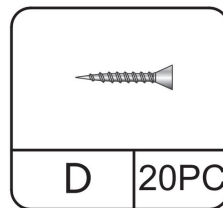
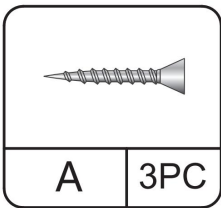
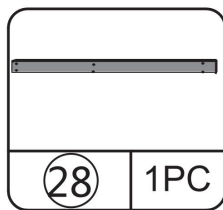
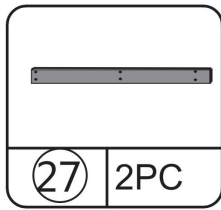

STEP 5

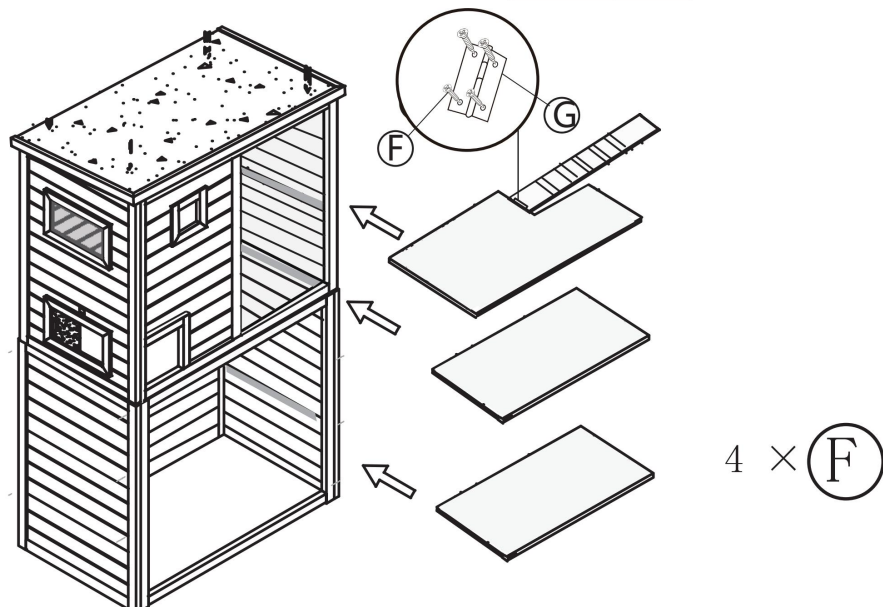
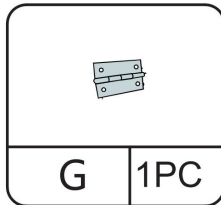
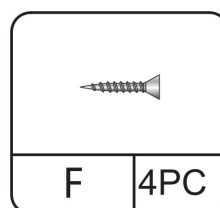
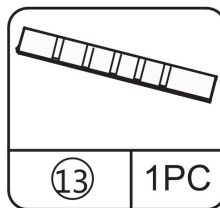
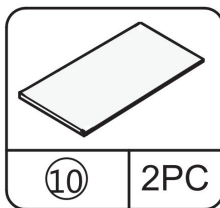
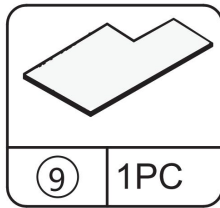

STEP 6

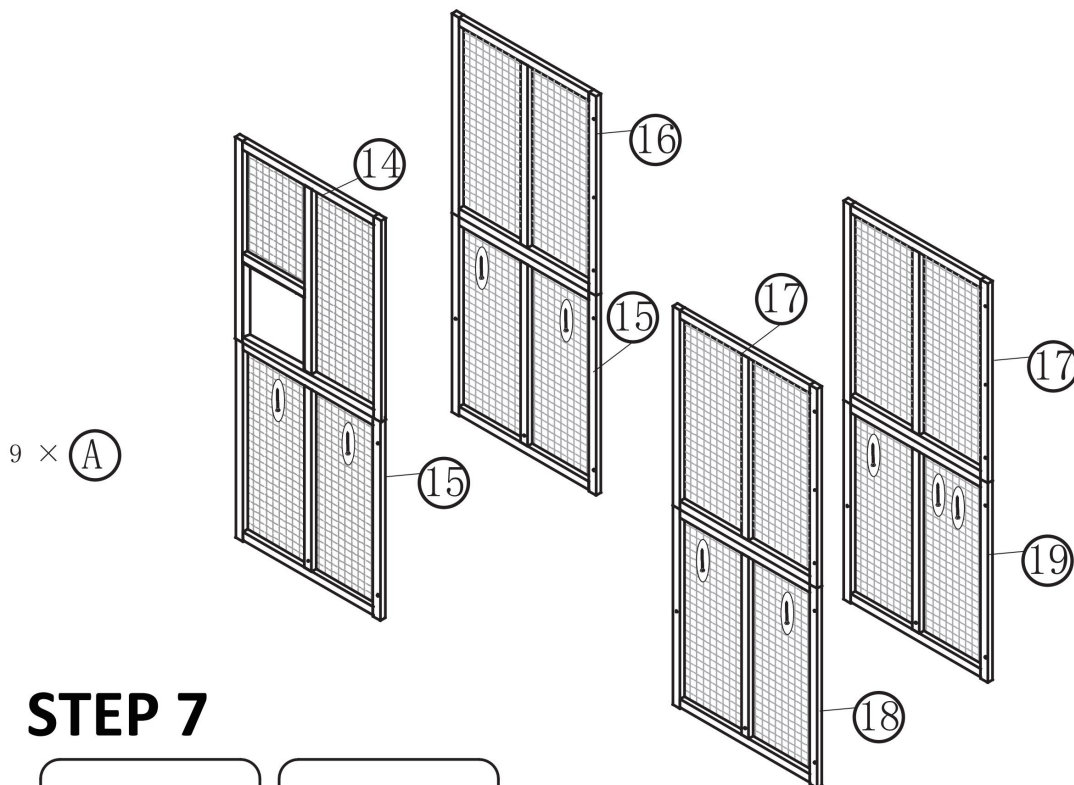
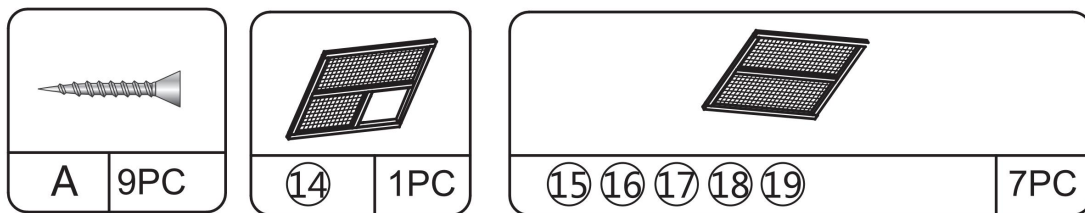

STEP 7

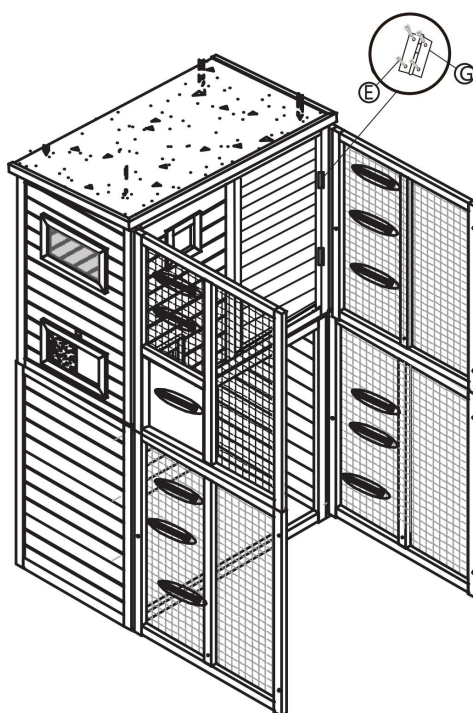
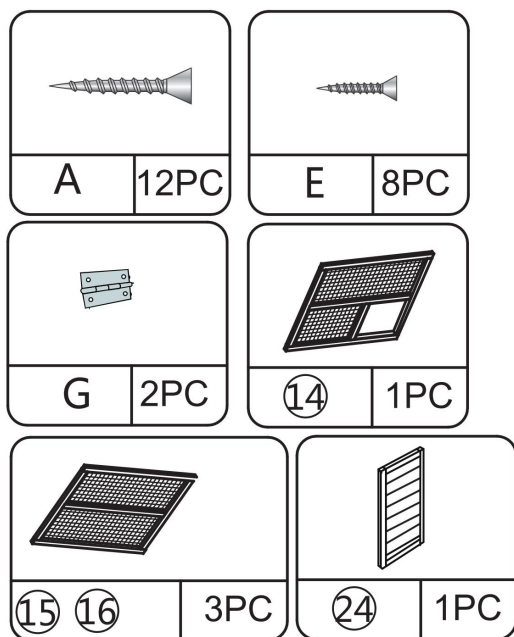

STEP 8

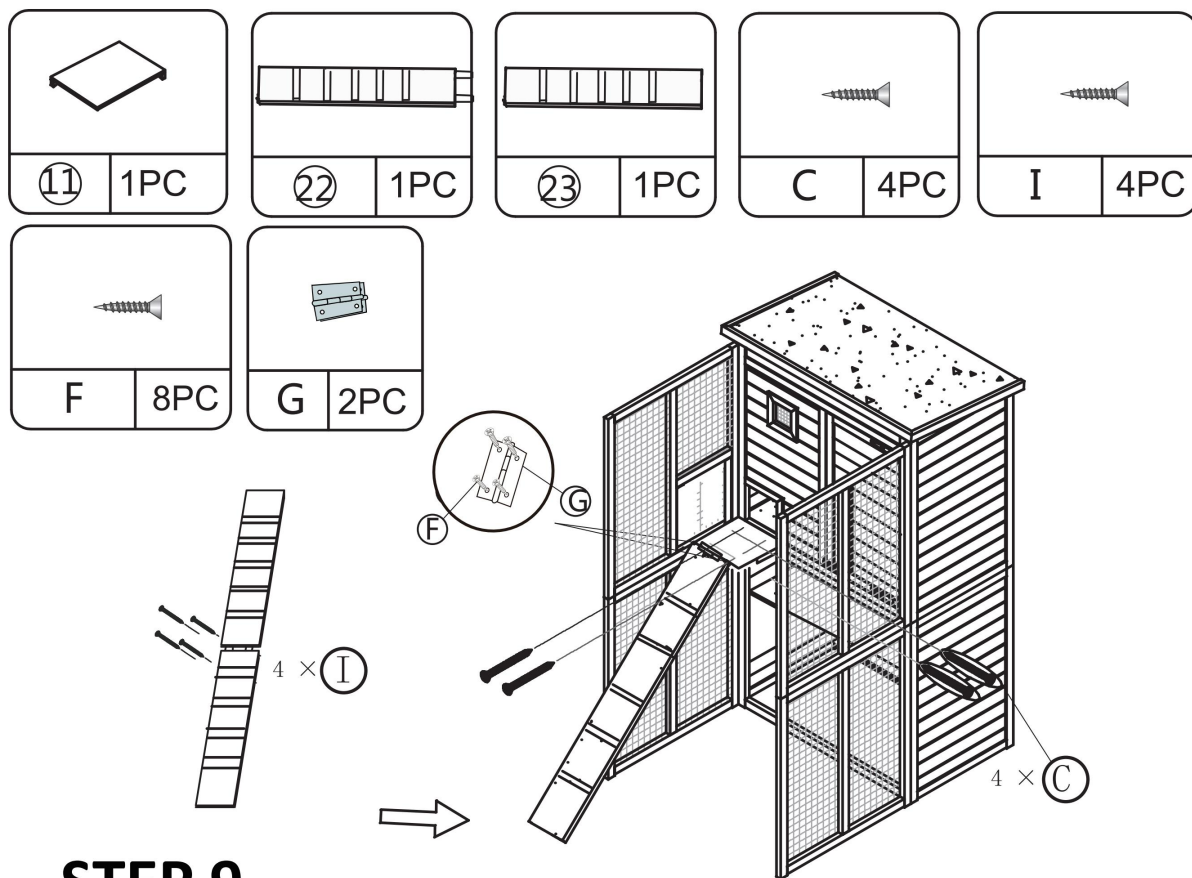

STEP 9

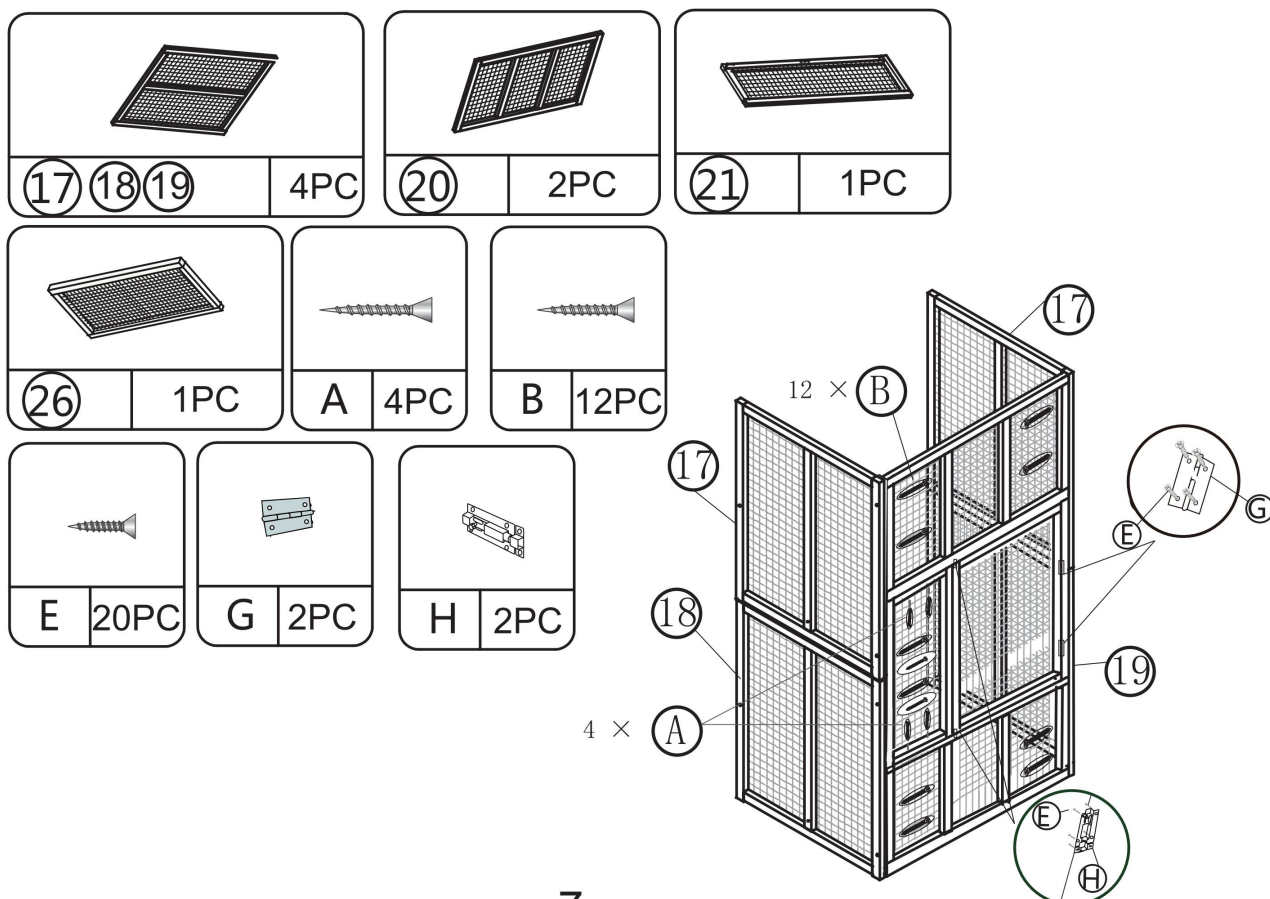

STEP 10

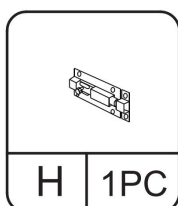
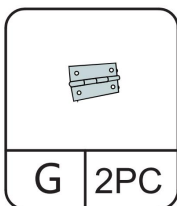
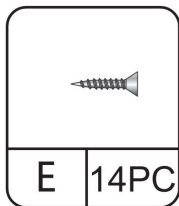
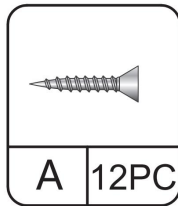
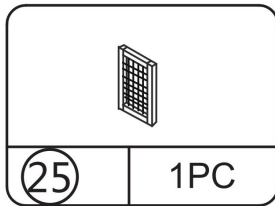

14 × E

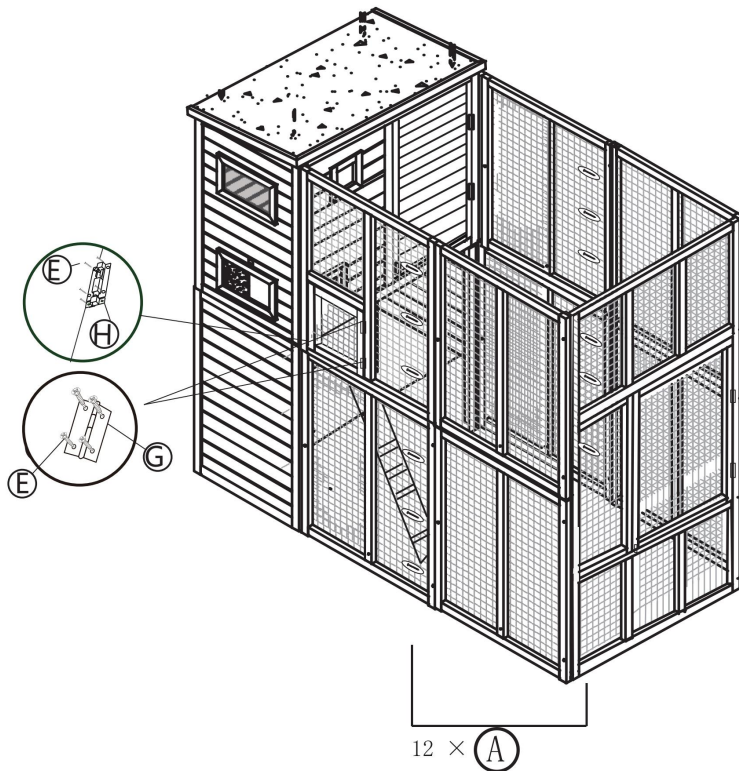

STEP 11

